

Góra

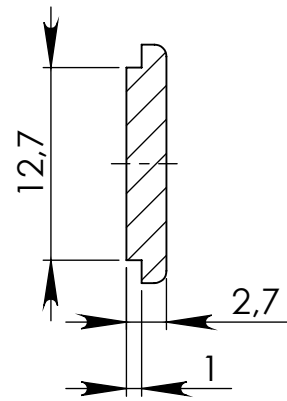

PRZEKRÓJ A-A

Dół

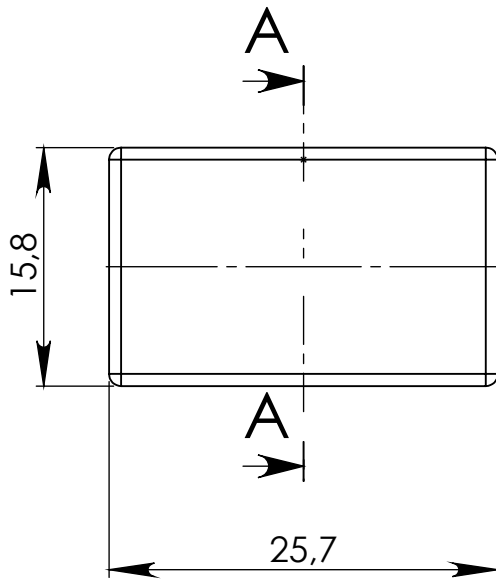
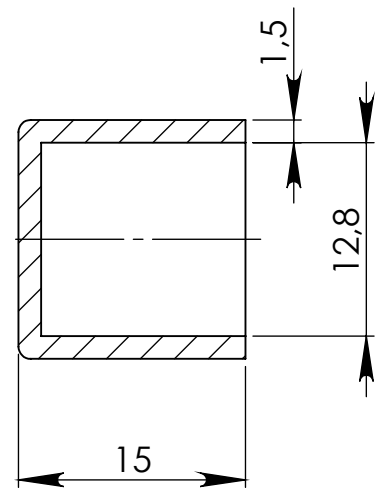
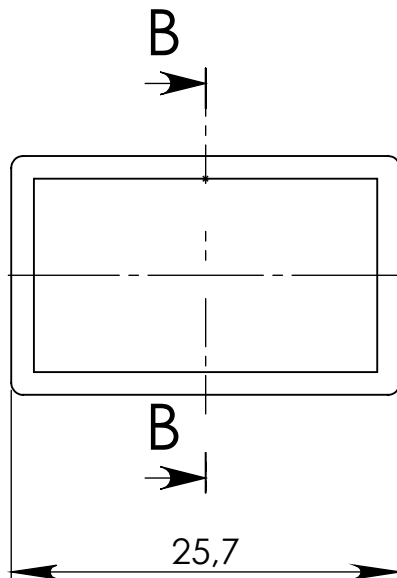

PRZEKRÓJ B-B

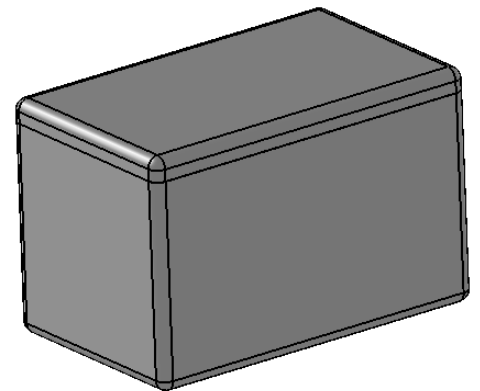

UWAGA: Wymiary w tolerancji $\pm 0,5\text{mm}$

Elementy składowe:
- obudowa góra,
- obudowa dół,

Format	Skala
A4	2:1

Nr produktu
KM 03



MASZCZYK®

Krzysztof Maszczyk
05-071 Sulejówek-Miłosna
ul. Mickiewicza 10
tel.: (022)783 45 20, fax.: (022)783 90 85
kom: 0602 726 086